

Heart for Alida

Maarten van Gelder

© 2000 Mar

This heart is the largest fully symmetrical heart you can make from one square piece of paper.

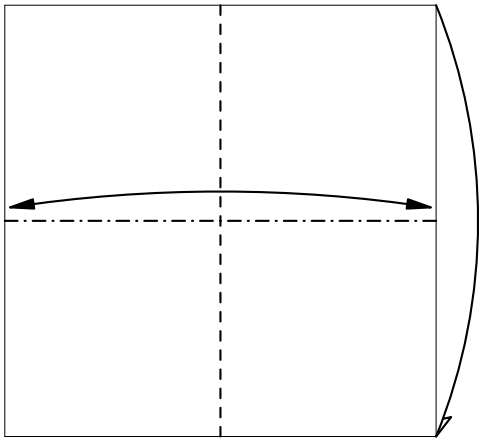

1

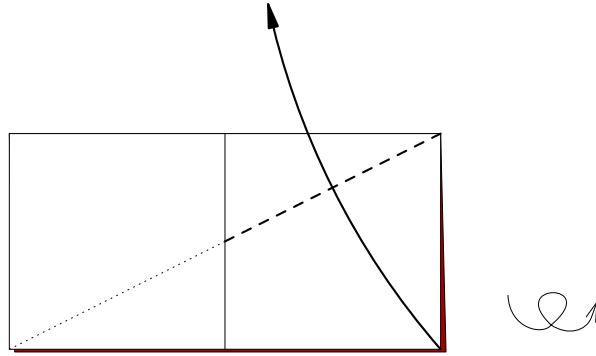

2

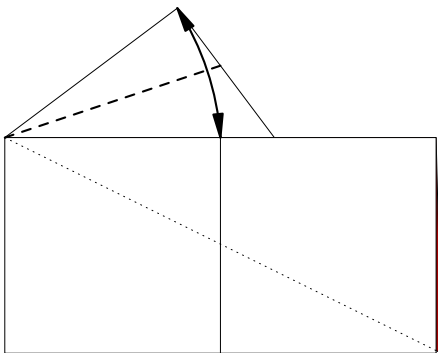

3

1

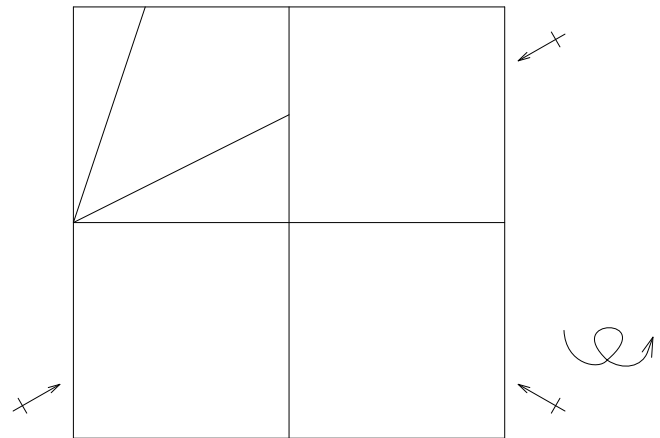

4

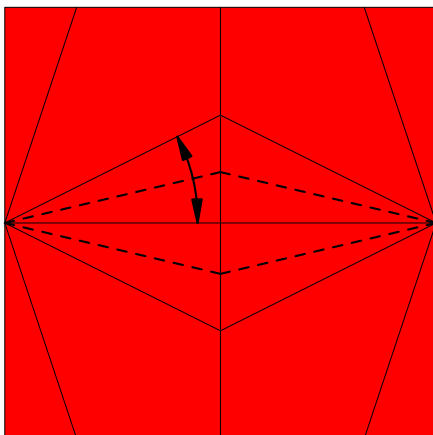

5

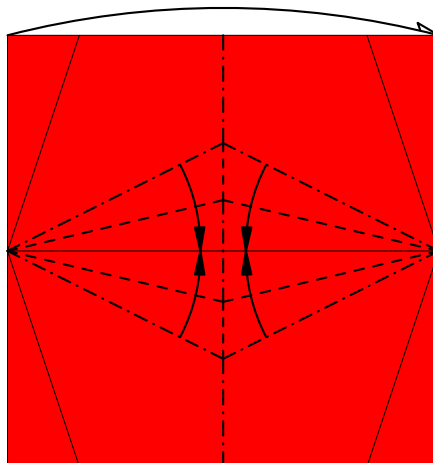

6

90

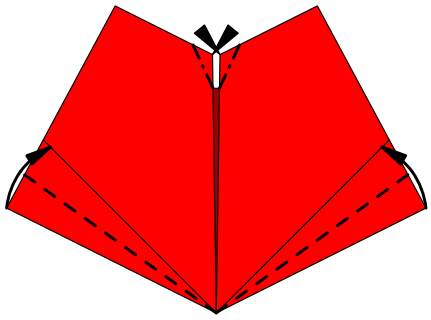

7

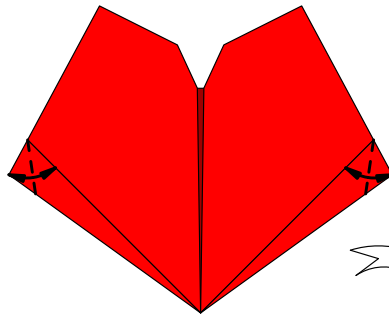

8

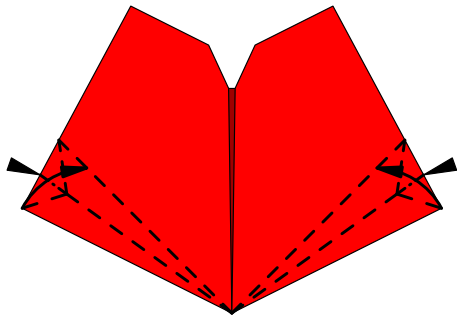

9 One layer

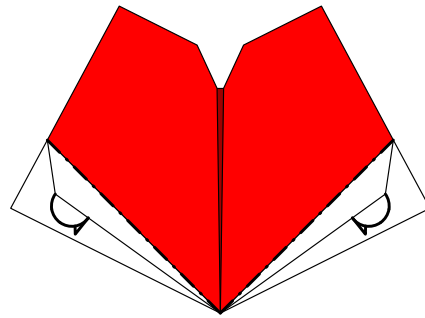

10

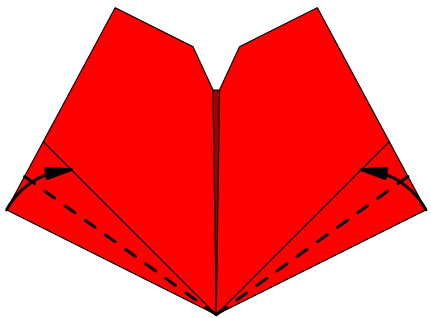

11

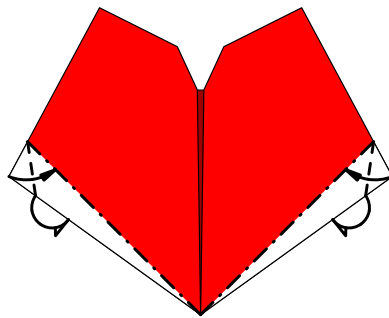

12 Put in pockets

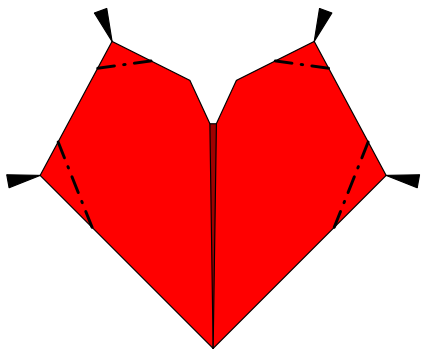

13

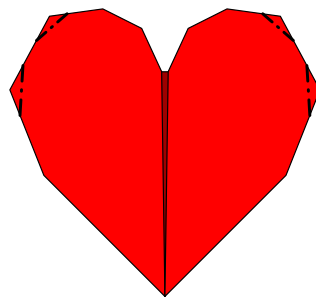

14 Make flaps and pockets as in 9-12

