

Miss Piggy

1

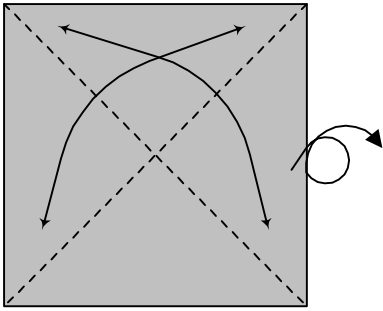

2

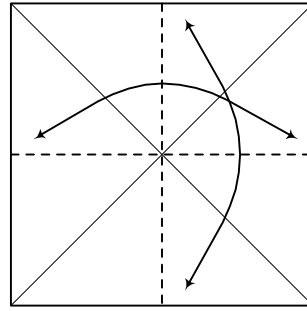

3

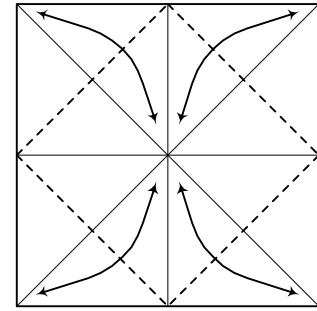

Crease the 4 corners.

4

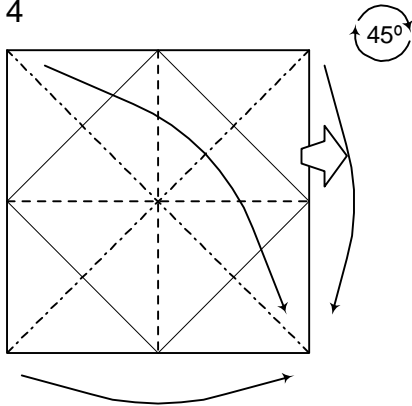

Preliminary fold.

5

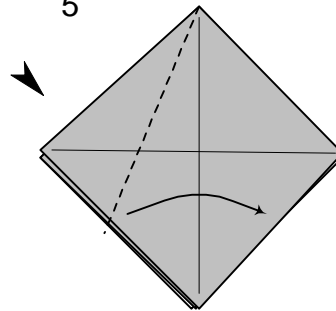

Squash fold.

6

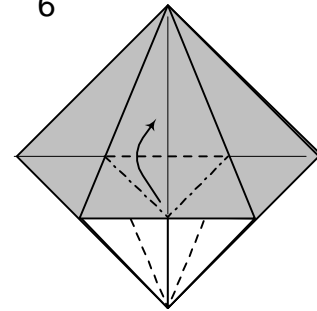

Petal fold.

7

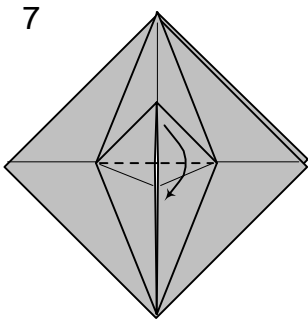

8

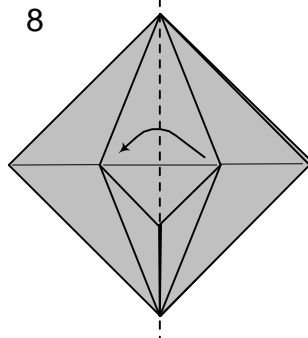

9

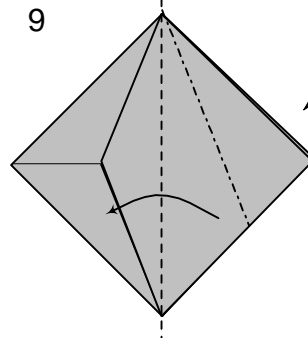

10

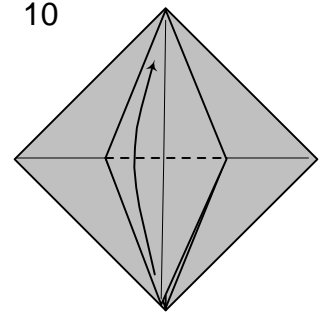

Repeat steps 5-8 on the right side

11

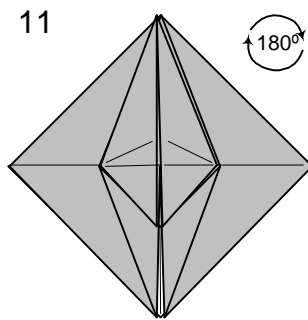

↑ 180°

12

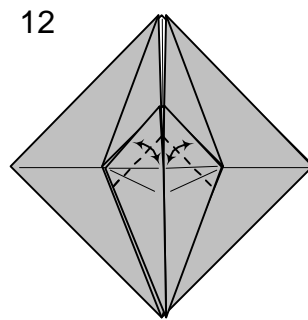

Crease one layer only, so the edge touches the centre.

13

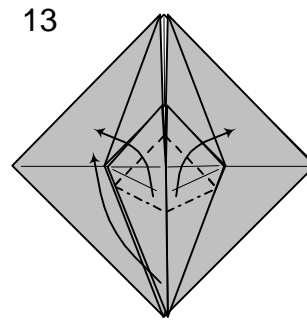

Squash fold using the crease made in step 12.

14

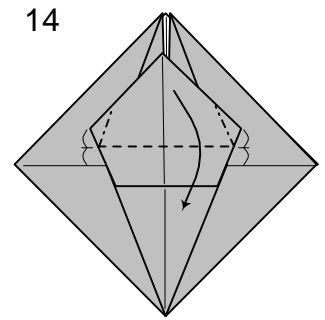

Squash again - see step 15 for where to flatten the sides.

Miss Piggy

15

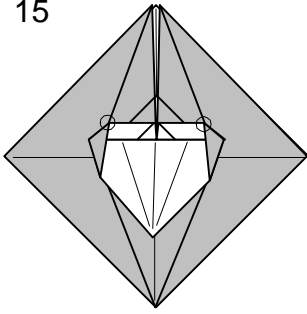

The tip of the squash fold should lie along the layer behind, as circled.

16

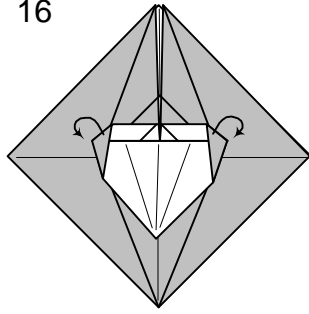

Wrap a single layer behind (colour change). To do this you need to partially unfold the model.

17

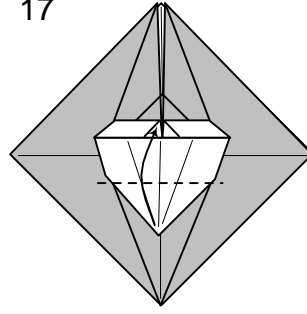

18

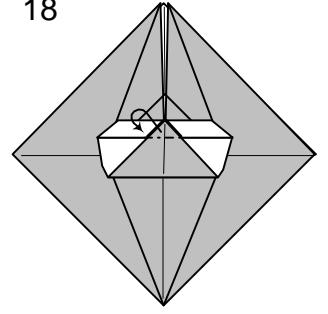

Tuck behind.

19

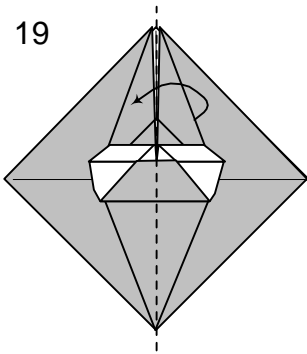

20

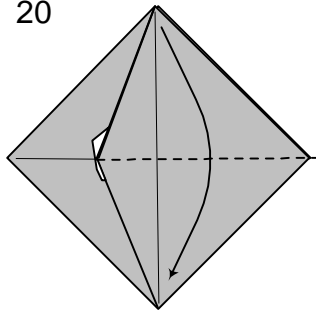

21

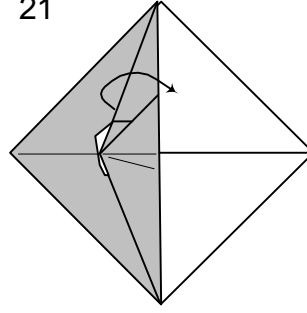

22

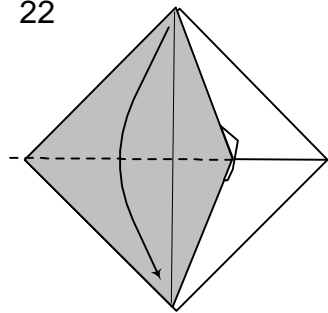

23

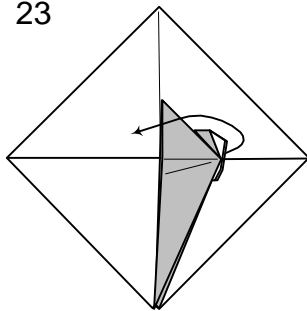

Swing back to make the model symmetrical

24

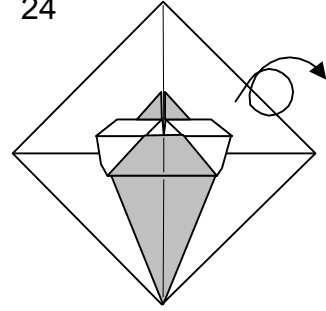

25

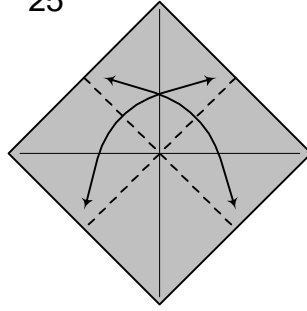

Crease the square but not the model behind

26

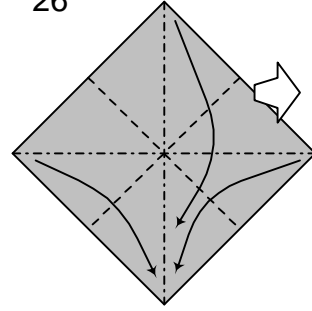

Preliminary fold

27

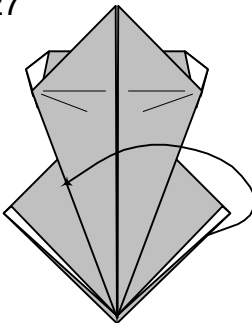

28

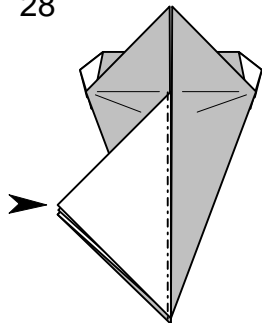

Inside reverse fold the top layer, a hidden double layer will also move.

29

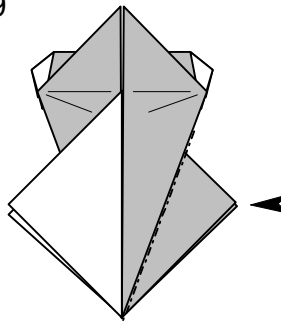

Inside reverse fold the top layer.

30

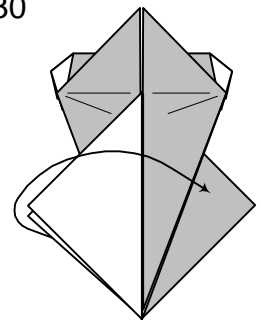

Repeat steps 27-29 on the left side.

Miss Piggy

31

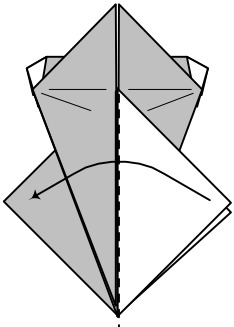

Fold flap to left so the model is symmetrical.

32

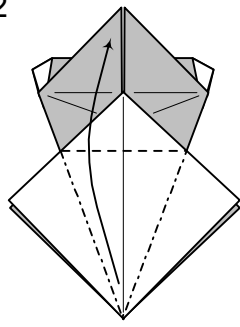

Petal fold.

33

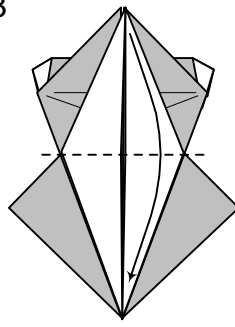

34

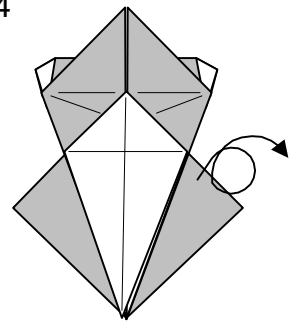

35

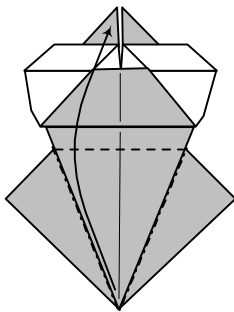

36

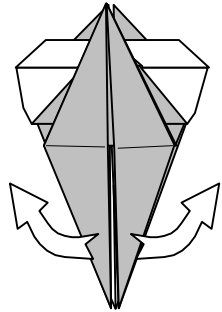

Pull the 2 points to unfold the 'bird base'.

37

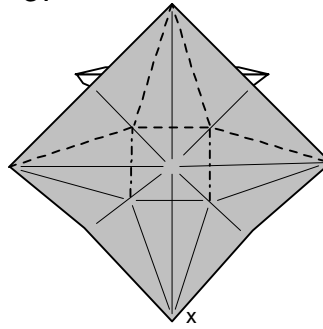

Valley fold the existing creases, bringing point 'X' towards you.

38

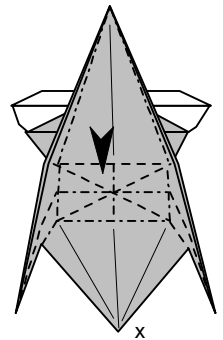

Sink the middle and bring the sides in to flatten.

39

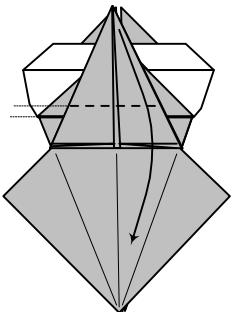

Fold the point down, creasing a little above the layer behind.

40

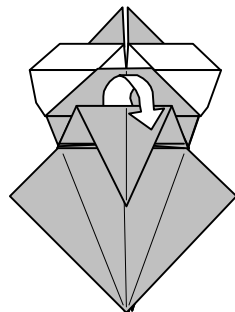

Bring the layer behind to the front.

41

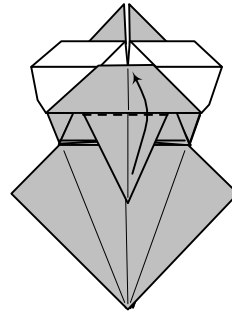

42

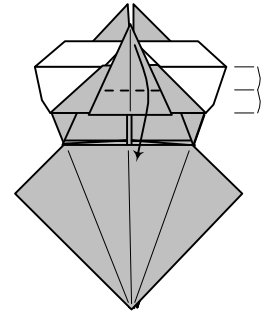

43

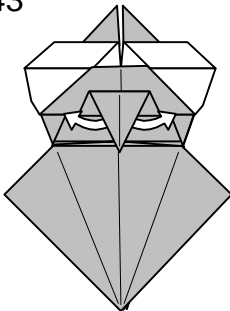

Pull out some paper.

44

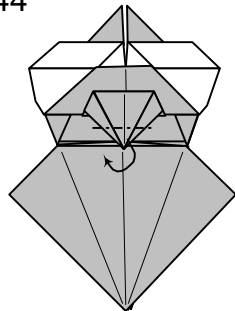

45

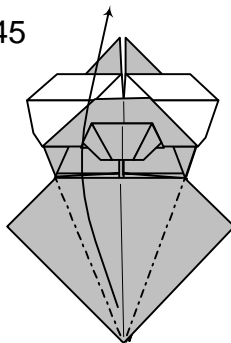

46

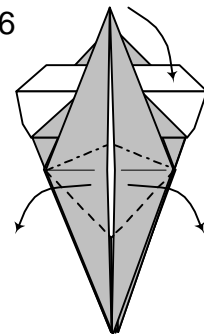

Squash fold. The valley creases line up with the edges of the hidden sunk point.

Miss Piggy

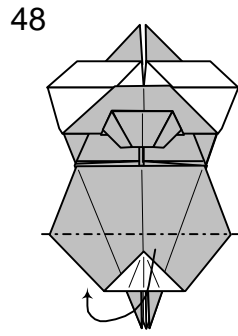
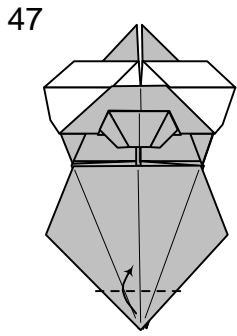

Tuck inside.

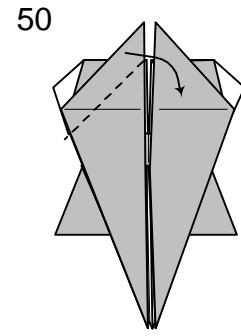
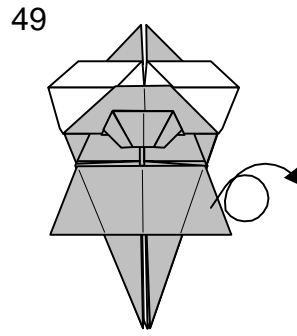

Valley fold as far as possible.

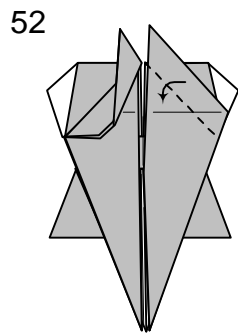
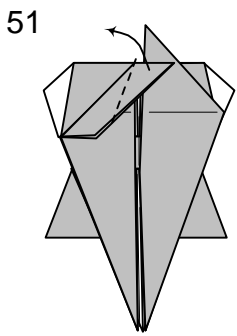

Repeat steps 50-51 on the other side.

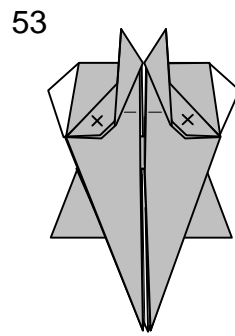

Separate the double layers and allow 'X' to move behind.

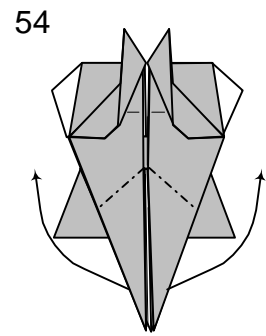

Inside reverse folds.

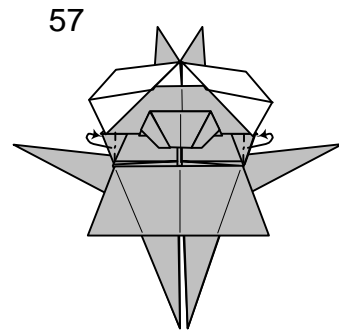
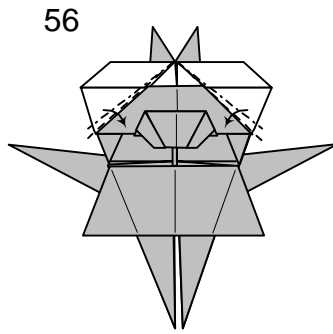
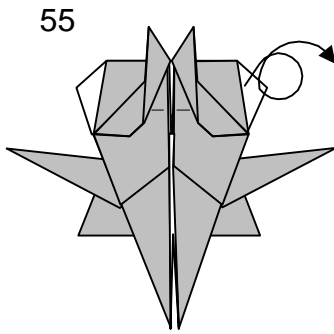

Mountain fold to narrow the neck (repeat behind).

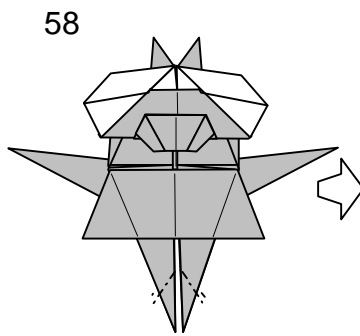

Squash fold the feet.

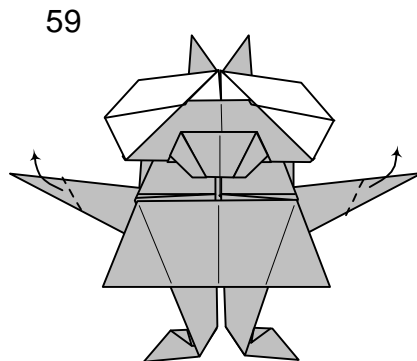

Make soft squash folds for the hands.

